

DATASHEET

Similis

SR4C005 • lamiiANT®



Features

- Antenna for 3G and 4G/LTE applications including MIMO
- GSM850, GSM900, DCS1800, PCS1900, WCDMA2100, LTE B7 (2500-2690MHz), LTE B40 (2300 – 2400 MHz)
- Low profile innovative design
- Incorporates DFI (Designed For Integration) to prevent de-tuning
- Maintains high performance within low profile package
- Supplied on Tape and Reel
- Automotive temperature rating

1. Description

Similis uses a ground plane on the host PCB to radiate efficiently, as well as requiring a clearance area around the antenna. The antenna needs an external matching circuit to match it to the frequency bands used. The antenna is ideal for 3G and 4G, as well as diversity/MIMO antennas.

2. Applications

- Wearable devices
- Portable devices
- Remote monitoring / IoT devices
- Telematics systems
- Network equipment / Pico base-stations

3. General data

Frequency	824-960MHz 1710-2170MHz 2300-2400MHz 2500-2690MHz
Polarization	Linear
Operating temperature	-40°C to 140°C
Environmental condition test	ISO16750-4 5.1.1.1/5.1.2.1/5.3.2
Impedance with matching	50 Ω
Weight	<2.0g
Antenna type	SMD
Dimensions	40.0 x 10.0 x 1.7 (mm)

4. Part number

SR4C005

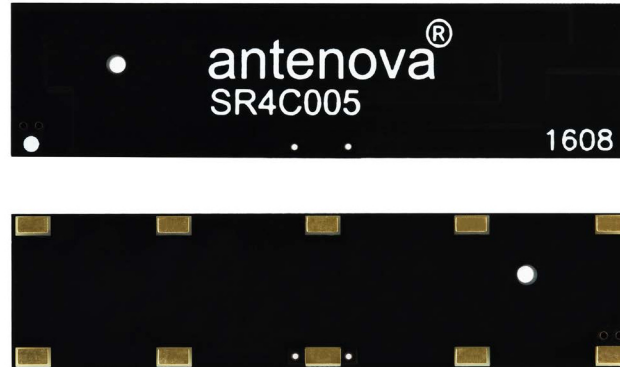

5. RF characteristics

Frequency	824-960 MHz	1710-2170 MHz
Peak gain	1.3dBi	3.4dBi
Average gain (Linear)	-2.5dBi	-2.2dBi
Average efficiency	>56%	>60%
Maximum return loss	-5dB	-7dB
Maximum VSWR	3.4:1	2.4:1

Frequency	2300-2400 MHz	2500-2690 MHz
Peak gain	3.7dBi	4.1dBi
Average gain (Linear)	-1.9dBi	-1.8dBi
Average efficiency	>65%	>66%
Maximum return loss	-10dB	-9dB
Maximum VSWR	1.9:1	1.9:1

All data measured on Antenna's evaluation PCB Part No. SR4C005-U1

6. RF performance

6.1. Return loss

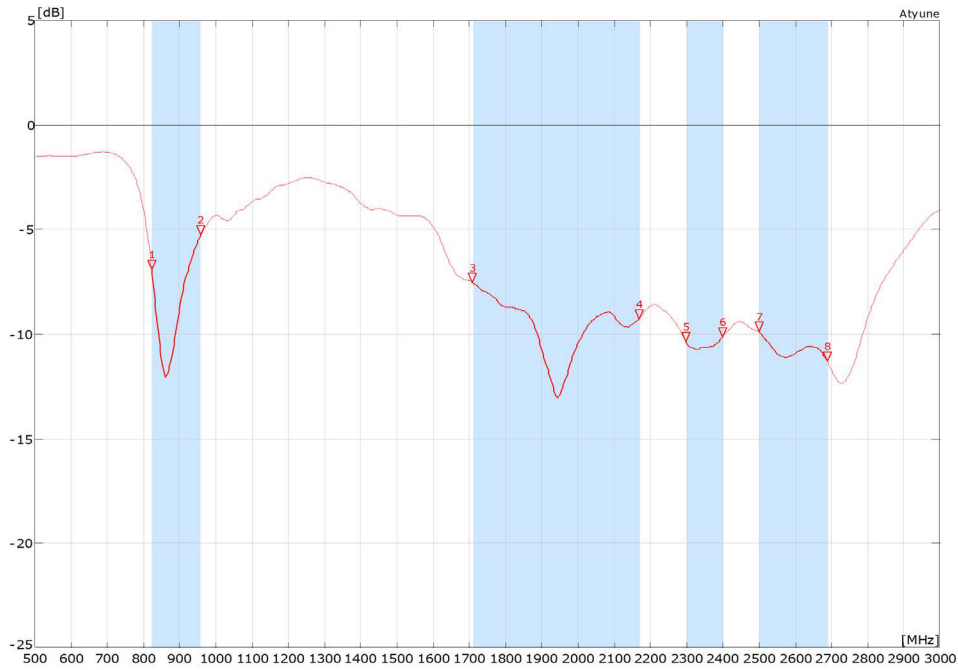

6.2. VSWR

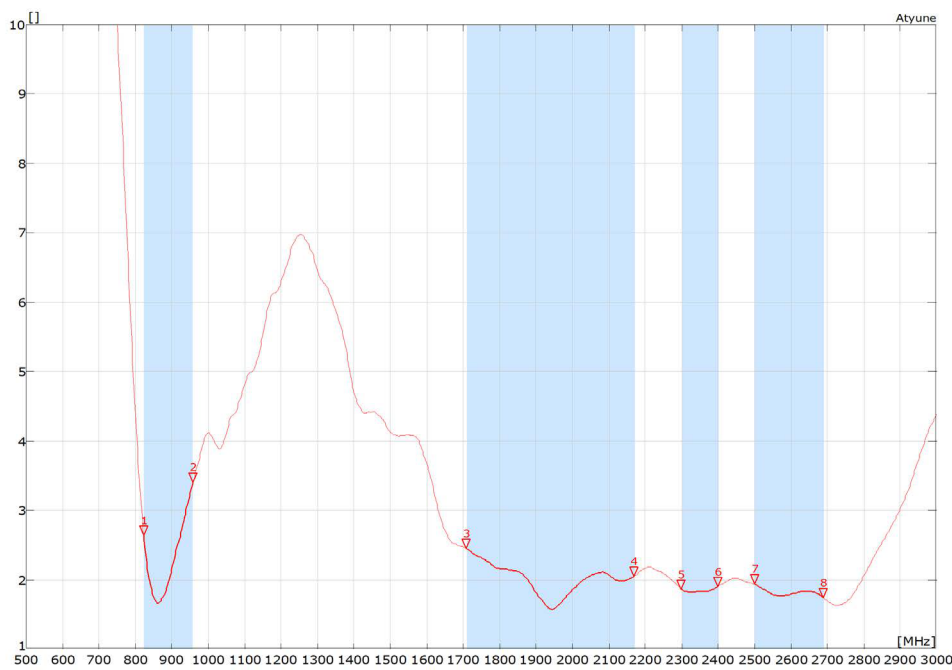

6.3. Efficiency

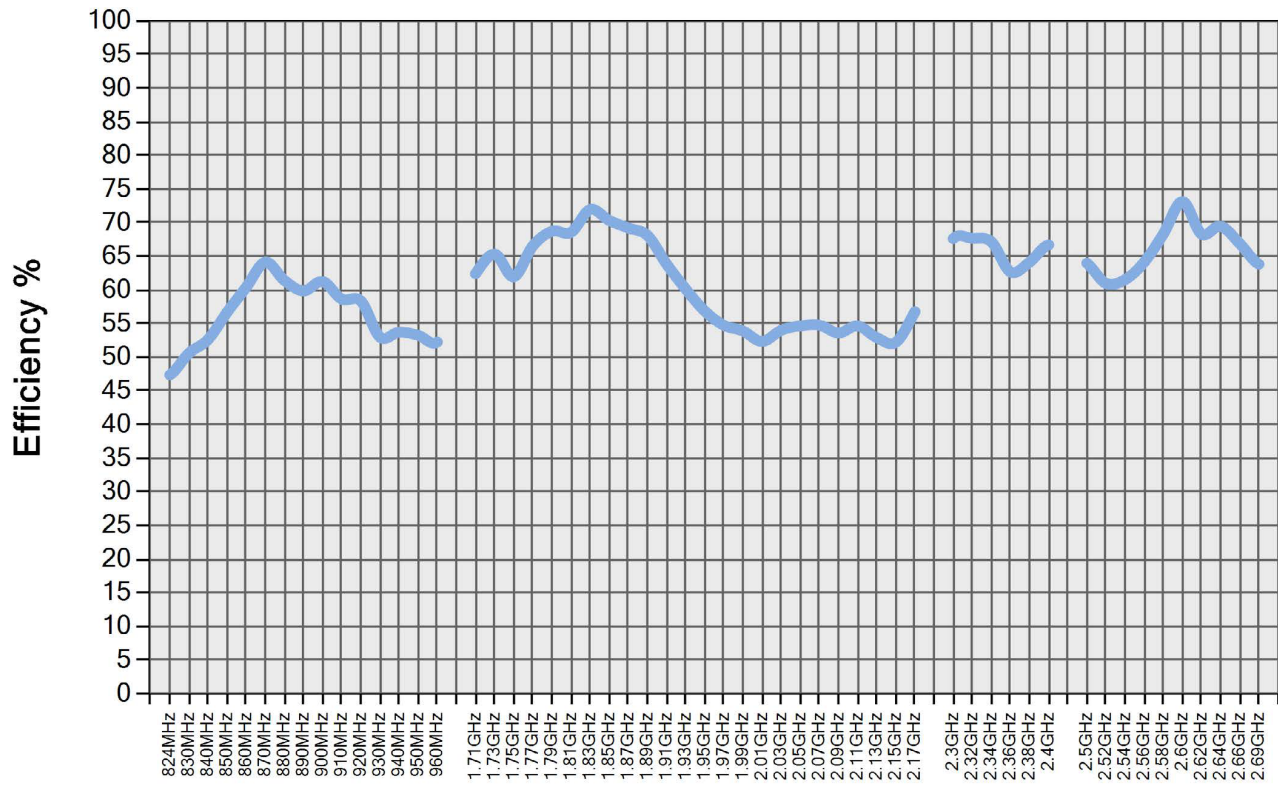

6.4. Antenna pattern

6.4.1. 824 MHz – 960 MHz

3D pattern at 880MHz

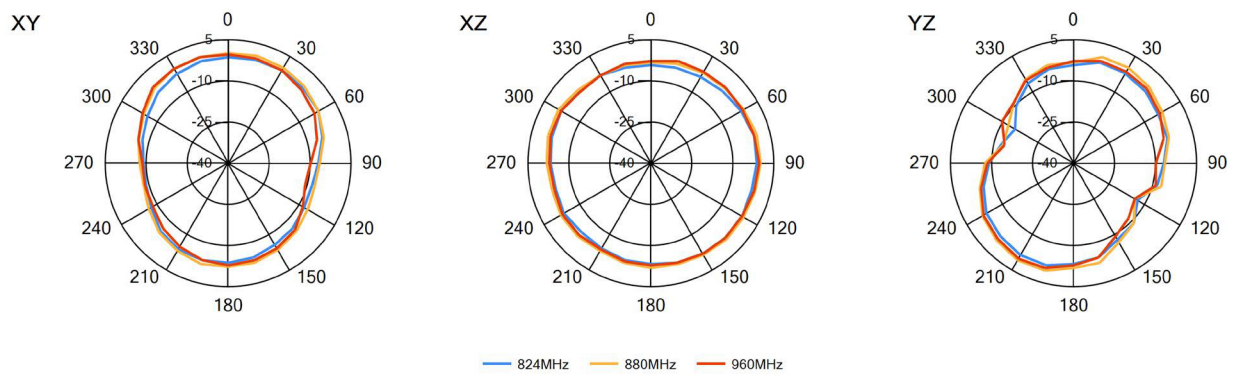
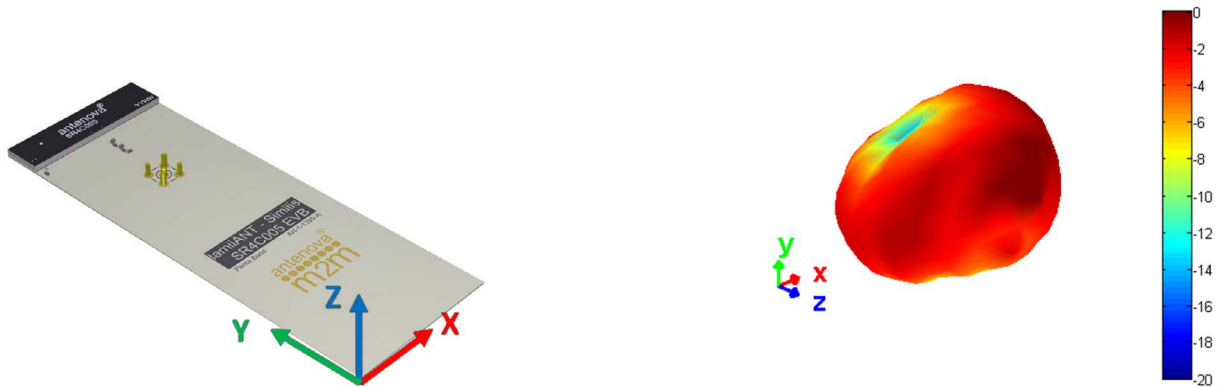

6.4.2. 1710 MHz – 2170 MHz

3D pattern at 1930MHz

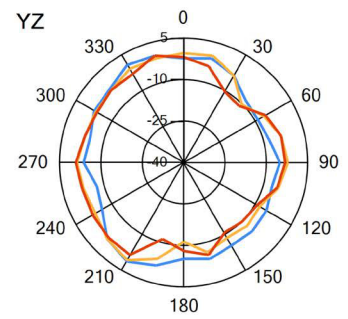
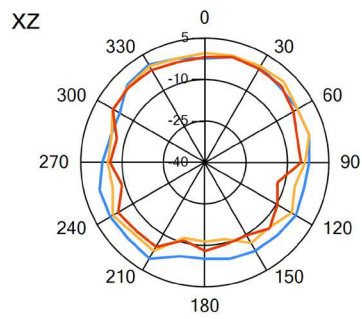
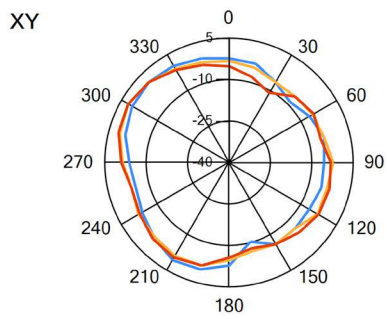
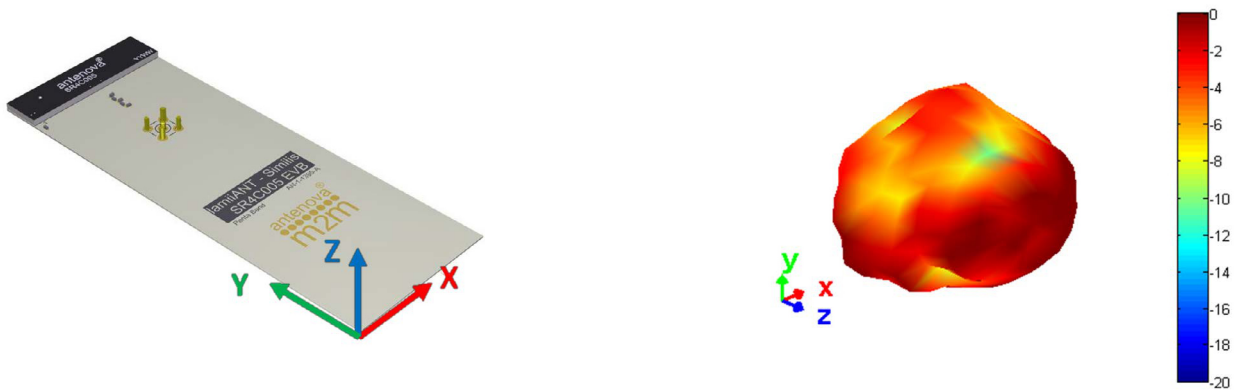

— 1.71GHz — 1.93GHz — 2.15GHz

6.4.3. 2300 MHz – 2400 MHz

3D pattern at 2340MHz

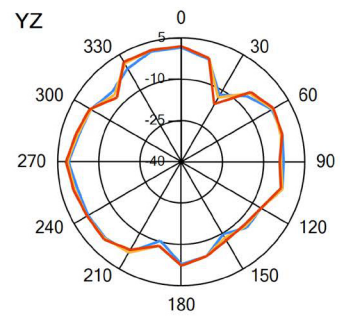
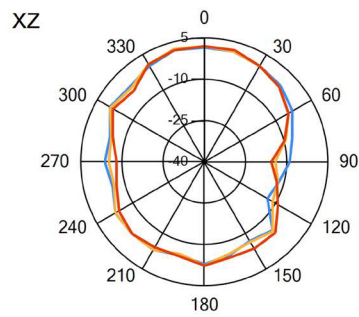
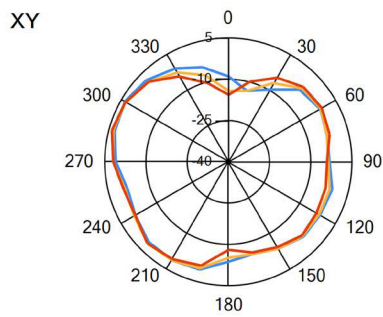
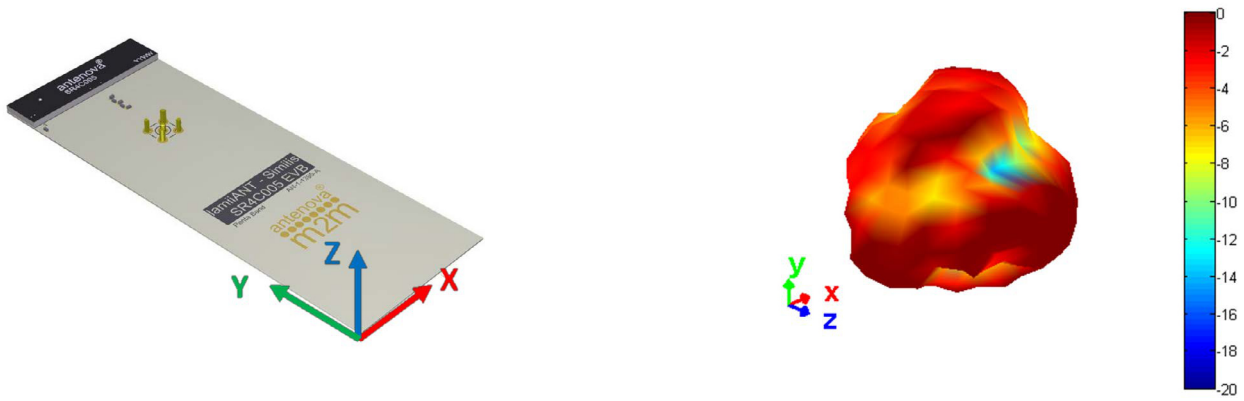

— 2.3GHz — 2.34GHz — 2.4GHz

6.4.4. 2500 MHz – 2690 MHz

3D pattern at 2580MHz

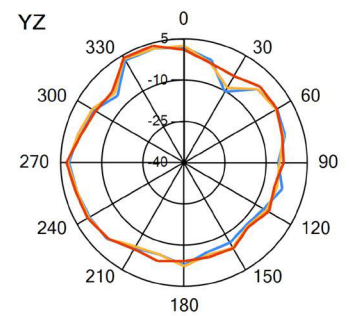
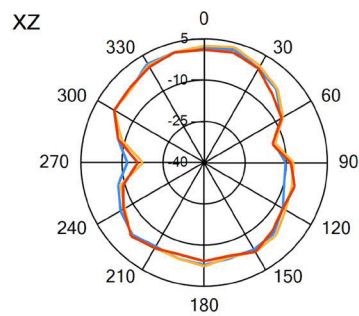
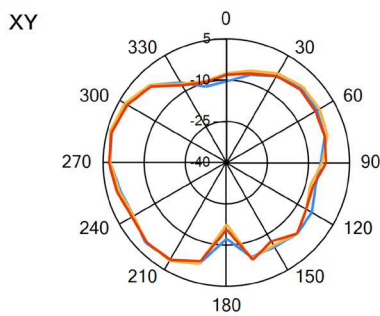
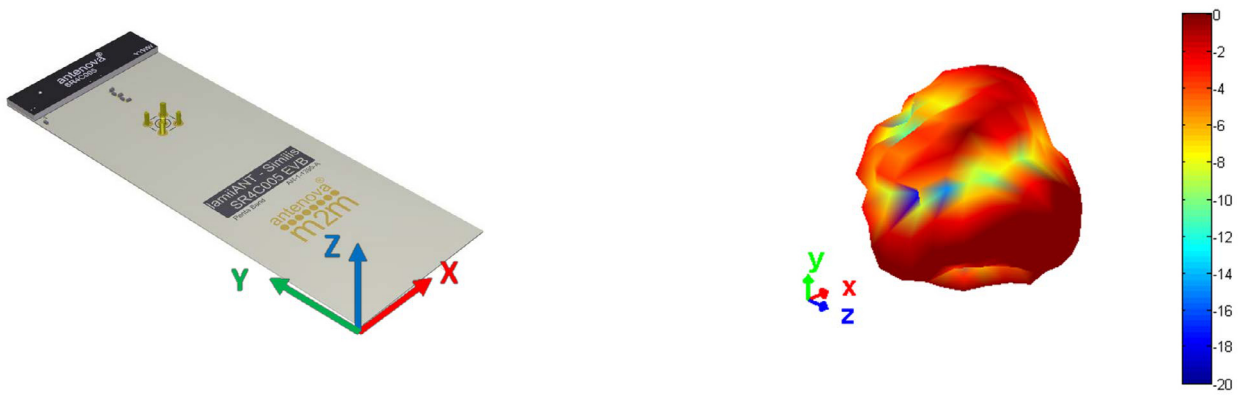

— 2.5GHz — 2.58GHz — 2.69GHz

7. Antenna dimensions



L	W	H
Length	Width	Height
40.0 ±0.1	10.0 ±0.1	1.7 ±0.1

All dimensions in (mm)

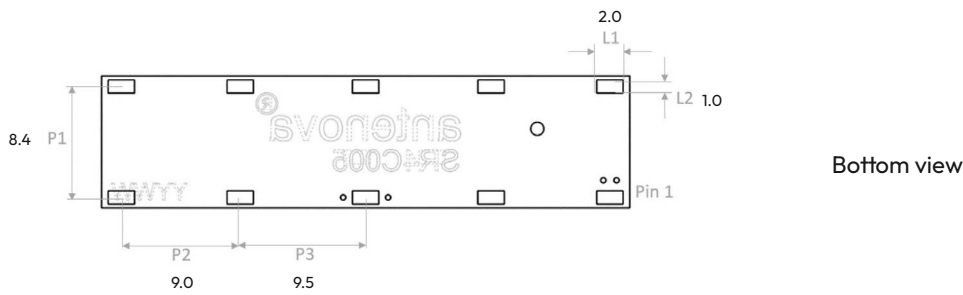

8. Schematic symbol and pin definition

The circuit symbol for the antenna is shown below. The antenna has 10 pins with only 2 as functional. All other pins are for mechanical strength.

Pin	Description
3	Feed (Transceiver port)
1	Return/GND
2, 4, 5, 6, 7, 8, 9, 10	NC (Not used, mechanical only)

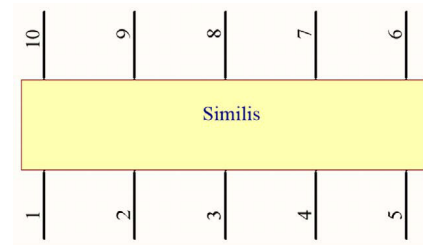

9. Host PCB footprint

The recommended host PCB footprint is below.

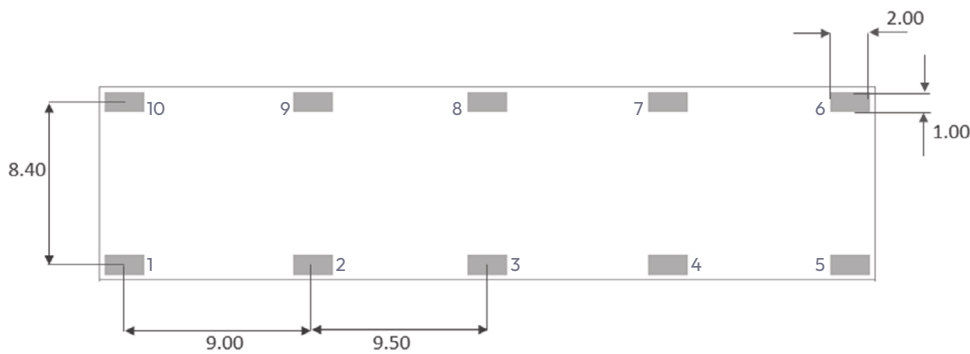

Pads 1-10 = 2.0 x 1.0 (mm)

10. Electrical interface

10.1. Transmission line

All transmission lines should be designed to have a characteristic impedance of 50Ω .

- The length of each transmission lines should be kept to a minimum
- All other parts of the RF system like transceivers, power amplifiers, etc, should also be designed to have a 50Ω impedance

A co-planar transmission line can be designed using an online transmission line calculator tool, such as:

<https://blog.antenova.com/rf-transmission-line-calculator>

The PCB thickness, copper thickness and substrate dielectric constant are entered, then the tool calculates the transmission line width and gaps on either side of the track to give a 50Ω impedance.

10.2. Matching circuit

The antenna requires a matching circuit that must be optimized for each product. The matching circuit will require up to six components and the following circuit should be designed into the host PCB. Not all components may be required but should be included as a precaution. The matching network should be placed close to the antenna feed to ensure it is optionally effective in tuning the antenna.

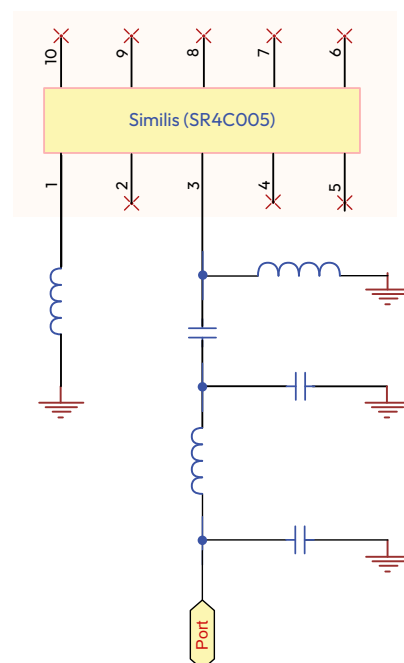

11. Antenna integration guide

We recommend the following during the design phase to maximise antenna performance and minimize noise:

- Minimum 4 layer PCB
- Route signals and power internally where possible
- Flood all layers with ground
- Knit ground on all layers together with plenty of vias

Follow placement guidance carefully. Antenova provide technical support to help you with your design, and also provide design assistance on PTCRB certification. Register for an account on <https://ask.antenova.com/> to access technical support.

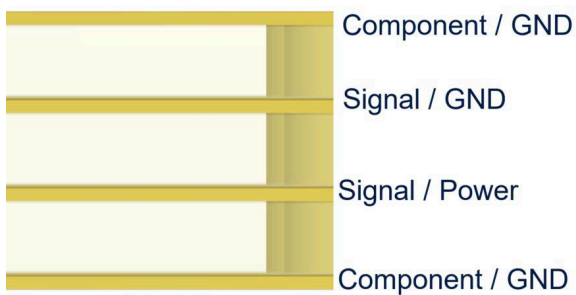

11.1. Antenna placement

The best position for the antenna is in the corner of the short side of the PCB. This allows the longer side of the PCB to be a ground plane, a long ground plane improves the antenna's efficiency. The antenna requires clearance ideally in 5 spatial directions as shown below. Where this cannot be achieved you should keep as many clear as possible to a minimum of 3. Please note performance will degrade with fewer clearances.

The Antenova placement tool can be used to advise on antenna placement, see: <https://blog.antenova.com/intelligent-antenna-selection-and-placement-tool-antenova>

Correct



Incorrect

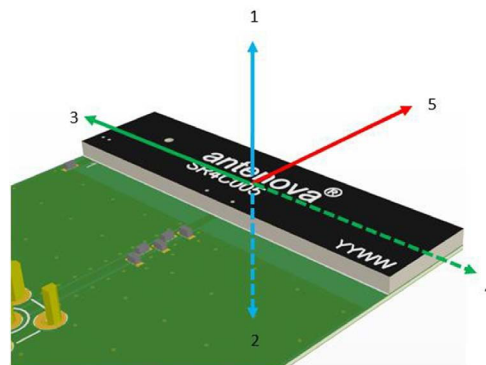
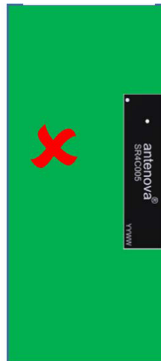

11.2. Host PCB layout

The host PCB must be designed using the PCB footprint shown with the correct clearances. An example of the PCB layout shows the antenna footprint. Please note this clearance area is critical to the performance of the antenna and must be applied through all layers of the PCB.

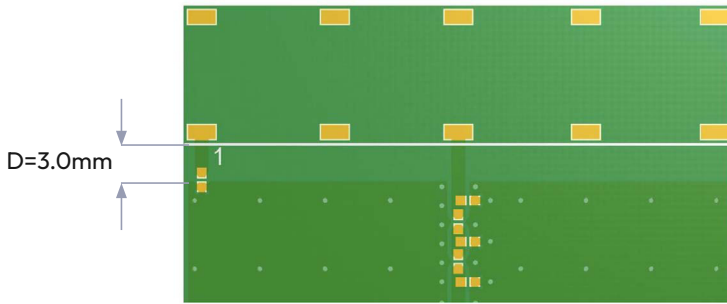

All dimensions in (mm)

11.3. Host PCB clearance

The diagram below shows the antenna footprint and clearance through all layers on the PCB. Only the antenna pads and connections to feed and GND are present within this clearance area.

Placement of components and GND with traces adjacent to the antenna should maintain a minimum clearance of 15mm from either side. The antenna should therefore be placed in the corner to only have one side affected.

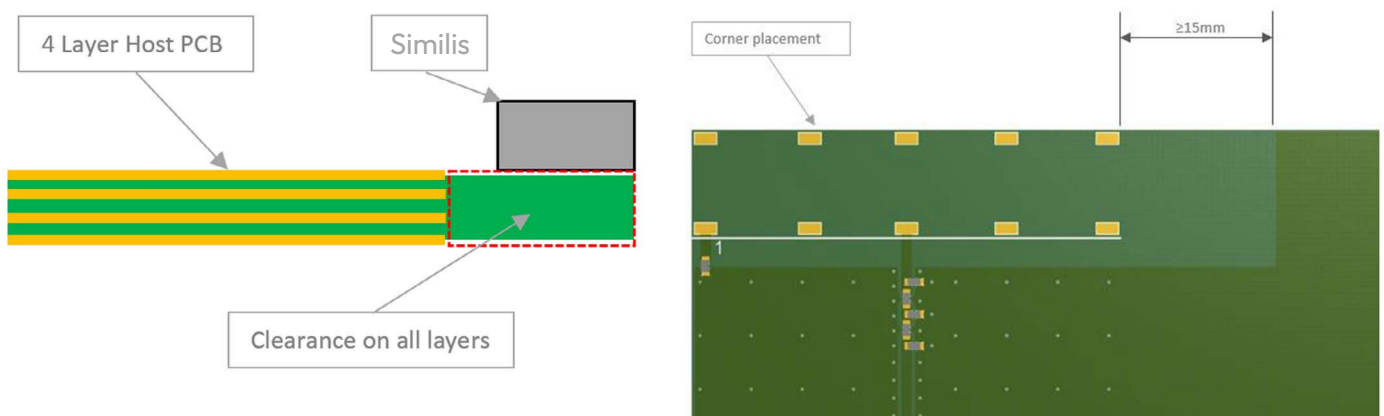

12. Reference board

A reference board is used for evaluating the antenna SR4C005 and it includes a SMA female connector. (Part number: SR4C005-U1).

To order a reference board please see antenna.com

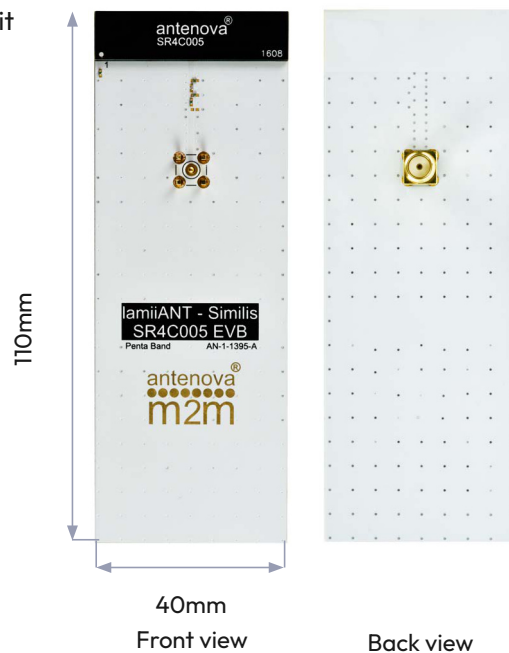

12.1. Reference board matching circuit

Designator	Type	Value	Description
L1	Inductor	1.2nH	Murata LQG15HN series
L2	Inductor	22nH	Murata LQG15HN series
L3	Inductor	2.7nH	Murata LQG15HN series
C1	Capacitor	12pF	Murata GJM15 series
C2, C3	Capacitor	0.5pF	Murata GJM15 series

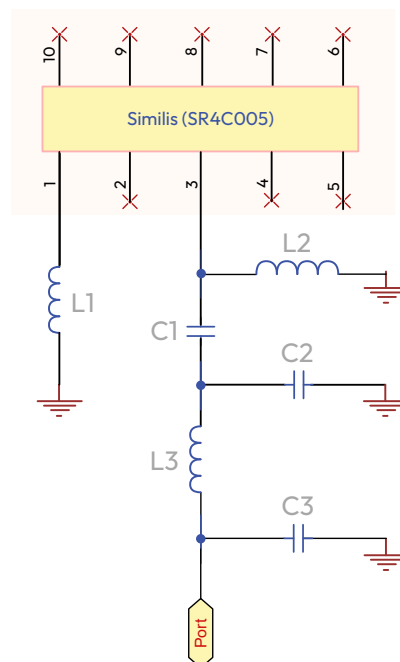

13. Soldering

This antenna is suitable for lead free soldering. The reflow profile should be adjusted to suit the device, oven and solder paste, while observing the following conditions:

- For leaded soldering, the maximum temperature should not exceed 240 °C.
- For lead free soldering, a maximum temperature of 255 °C for no more than 20 seconds is permitted.
- The antenna should not be exposed to temperatures exceeding 120 °C more than 3 times during the soldering process.

14. Hazardous material regulation conformance

The antenna has been tested to conform to RoHS and REACH requirements. A certificate of conformance is available from Antenova's website.

15. Packaging

15.1. Optimal storage conditions

Temperature	-10°C to 40°C
Humidity	Less than 75% RH
Shelf life	24 Months
Storage place	Away from corrosive gas and direct sunlight
Packaging	Reels should be stored in unopened sealed manufacturer's plastic packaging.
MSL level	1

Note: Storage of open reels of antennas is not recommended due to possible oxidization of pads on antennas. If short term storage is necessary, then it is highly recommended that the bag containing the antenna reel is re-sealed and stored in conditions as described in the table above.

The shelf life of the antenna is 2 years provided the factory seal on the package has not been broken.

15.2. Tape characteristics

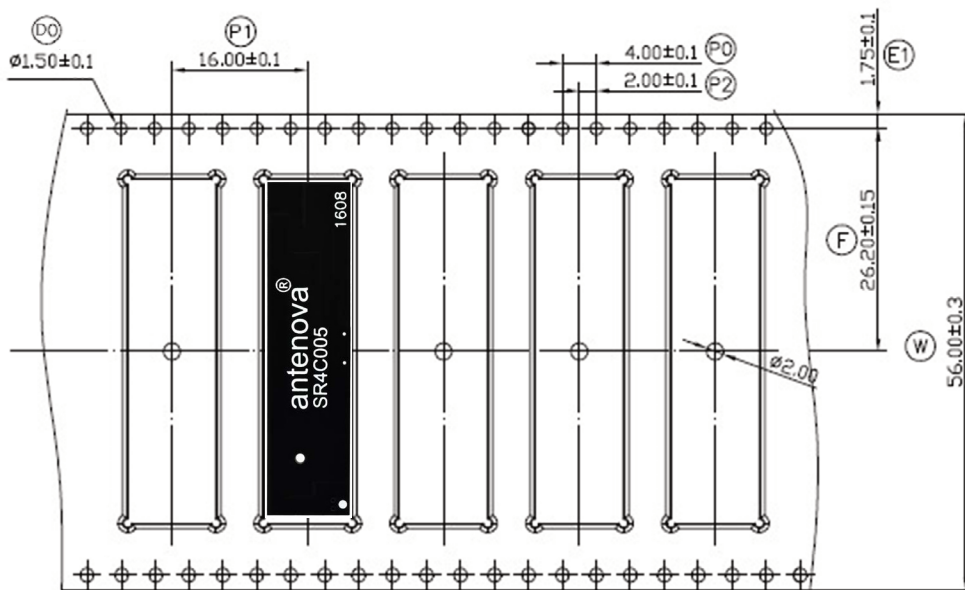

P0	P1	P2	D0
4.00 ± 0.1	16.00 ± 0.1	2.00 ± 0.1	1.50 ± 0.1

E	F	W
1.75 ± 0.1	26.20 ± 0.15	56.00 ± 0.3

All dimensions in (mm)

Quantity	Leading space	Trailing space
1000 pcs / reel	25 blank antenna holders	25 blank antenna holders

15.3. Reel dimensions

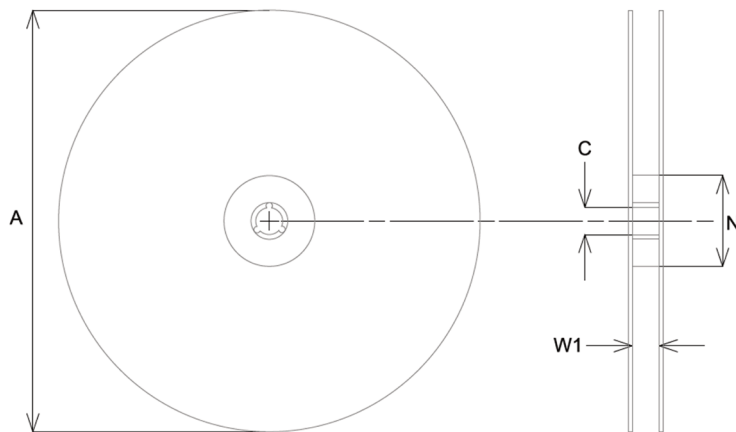

A	C	N	W1
330.0 ± 2.0	13.0 ± 0.5	178.0 ± 0.5	56 ± 2.0

All dimensions in (mm)

15.4. Box dimensions

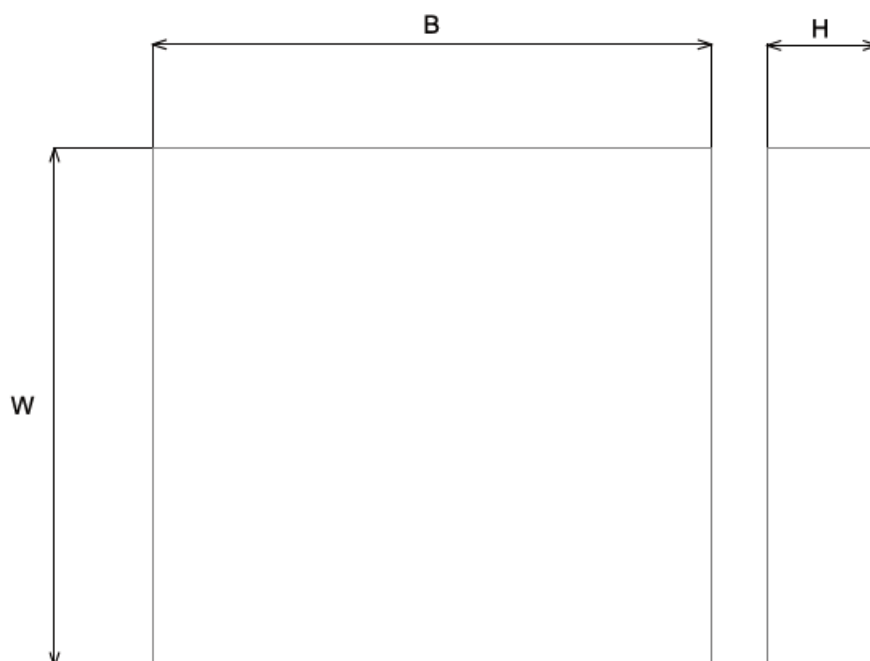

Width (W)	Breadth (B)	Height (H)
350mm	355mm	70mm

15.5. Bag properties

Reels are supplied in protective plastic packaging.

15.6. Reel label information

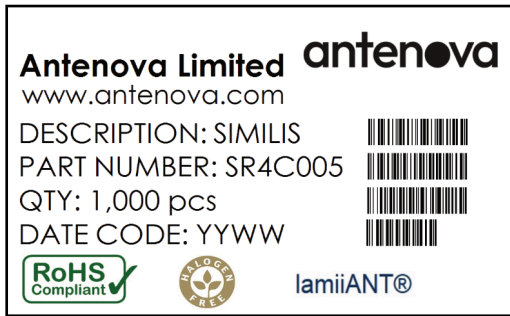

Quality statements

Antenova's products conform to REACH and RoHS legislation. For our statements regarding these and other quality standards, please see antenova.com.

Antenova reserves all rights to the contents of this document. Antenova gives no warranties based solely on the accuracy or completeness of the contents of this document and reserves the right to make changes to the specifications of the products described herein at any time and without notice.



Datasheet version

3.02 released 18th March 2026

Antenna design, integration and test resources

Product designers – the details contained in this datasheet will help you to complete your embedded antenna design. Please follow our technical advice carefully to obtain optimum antenna performance.

We aim to support our customers to create high performance wireless products. You will find a wealth of design resources, calculators and case studies to aid your design on our website.

Antenuova's design laboratories are equipped with the latest antenna design tools and test chambers. We provide antenna design, test and technical integration services to help you complete your design and obtain the required certifications.

If you cannot find the antenna you require in our product range, please contact us to discuss creating a custom antenna to meet your exact requirements.

Share knowledge with RF Experts around the world

ask.antenuova is a global forum for designers and engineers working with wireless technology

[Visit Ask.Antenuova](#)

Visit antenuova.com

Order antenna samples and evaluation boards, and read our antenna resources

[Visit antenuova.com](http://antenuova.com)

Request a volume quotation for antennas:

sales@antenuova.com

+ 44 (0) 23 9400 1023

Global headquarters

**Antenuova Ltd, 7 The Briars,
Waterberry Drive, Waterlooville,
Hampshire, PO7 7YH**